



**Packed and ready for use
NGI spare part kits.**

Our spare parts for bearing houses are packed and sold in bags with 25 pcs. A cover hand tool is included in each order for spare parts and bearing houses.

Spare parts for NGI Bearing houses

Easy replacement - sealings and covers

When you purchase certified hygienic bearing houses from NGI we recommend that you include our spare part kits.

We have more variations and sizes. Find more information on the next pages.

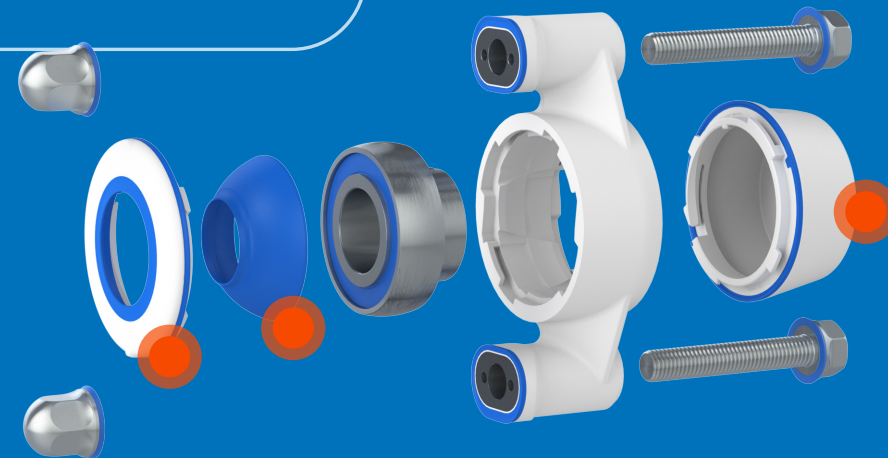

NGI A/S
Virkelyst 5
9400 Nørresundby
Denmark

+45 98 17 45 00
ngi@ngi.dk

NGI Italy
Via Guglielmo Jervis 4
10015 IVREA TO
Italy

+39 077 568 7010
ngi@ngi.dk

NGI Inc. USA
805 Satellite Blvd
Suwanee, GA 30024
USA

+1 (646) 201 9410
sales@ngi.dk

ngi-global.com

APPROVED



Spherical seals

Spare parts

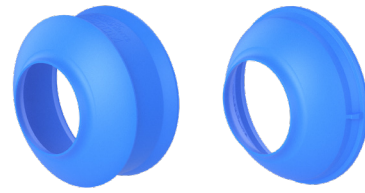



Spherical seals

All according to use, we recommend replacing the spherical seal as needed, depending on local conditions and applications.

Our spherical seal is unique and patented and follows the shaft and bearing and waterproof even when misaligned at more than 3 degrees.

Even though our spherical seal has a longer lifetime than equivalent products, this is a wearing part and eventually this part will need to be changed.

Please note that our spherical seals are lubrication-free.

SIZE D	SHAFT DIAMETER D1	SHAFT DIAMETER D1	SMALL /FLAT SEAL	MEDIUM SEAL	ARTICLE NUMBER
mm	mm	inches			
47	20		X		R950902
	20			X	R950901
		3/4"	X		R950904
		3/4"		X	R950903
52	25		X		R950906
	25			X	R950905
		1"	X		R950908
		1"		X	R950907
62	30		X		R950910
	30			X	R950909
		1 1/4"	X		R950913
		1 1/4"		X	R950912
72	35		X		R950950
	35			X	R950951
		1 3/8"	X		R950950
		1 3/8"		X	R950951
80	40		X		R950952
	40			X	R950953
		1 1/2"	X		R950954
		1 1/2"		X	R950955

We have two types of spherical seals, a small seal and a medium seal, and more sizes. The small seal is used for small open covers and the medium seal is used for open medium covers.

Find link to video showing how to replace the spherical seal at the next page.

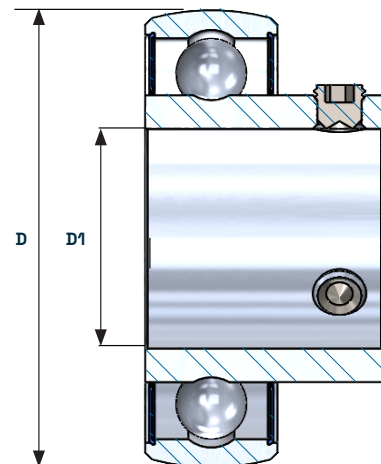

Covers

Spare parts

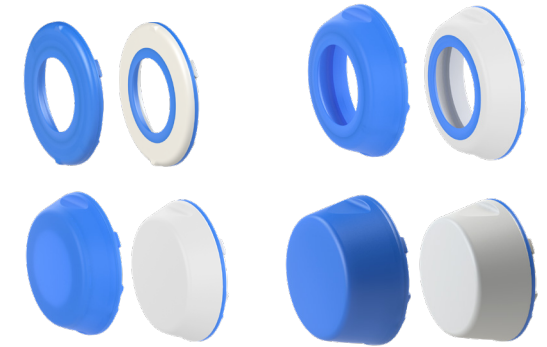

Covers

Our covers for the front and back of the bearing house are not wearing parts but can, however, be subject to damages.

We offer open and closed covers in a large range of sizes and colors.

The covers are produced in a high-strength, high-performance PA12 and optimized for food- and pharmaceutical industries.

Find links to video showing how to replace the covers below.

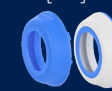
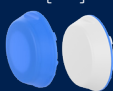
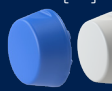
SIZE D	OPEN SMALL [OS]	OPEN MEDIUM [OM]	CLOSED MEDIUM [CM]	CLOSED LARGE [CL]	ARTICLE NUMBER WHITE	ARTICLE NUMBER BLUE
mm						
47	X				R950919	R950918
		X			R950917	R950916
			X		R950915	R950914
52	X				R950924	R950925
		X			R950923	R950922
			X		1020213	1020212
				X	R950920	R950921
62	X				R950932	R950931
		X			R950930	R950929
			X		R950926	R950928
72	X				R950956	R950957
		X			R950958	R950959
			X		R950960	R950961
				X	-	-
80	X				R950962	R950963
		X			R950965	R950967
			X		R950968	R950969
			X	-	-	

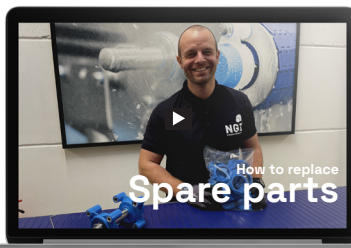



Replacement of spare parts on NGI bearing houses

Scan the code and see a short video showing how to replace the covers and spherical seals on our bearing houses.



reddot winner 2022

Cover hand tool for spare parts

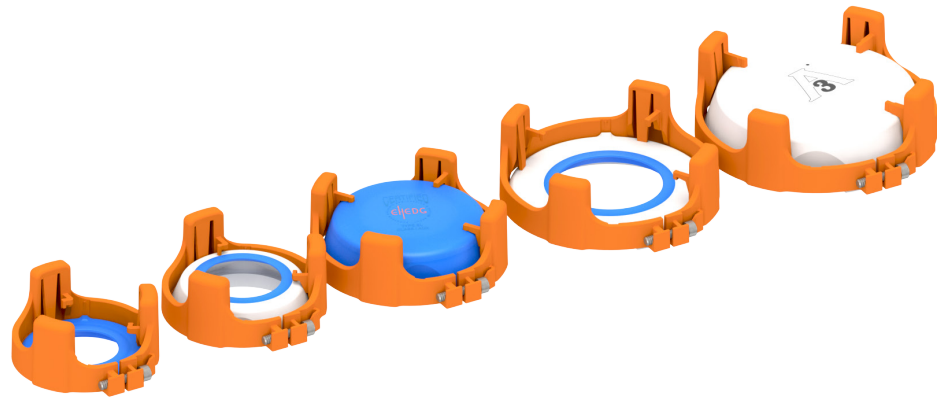

In all shipments and orders for bearing houses we include a cover hand tool with the order. The cover hand tool is a tool which makes the replacement of covers and spherical seals much easier.

Besides including the cover hand tool in all orders for bearing houses, the tool will also be included in all orders for spare parts.

In the spare part video - scan the QR code on the previous page - you can see how to replace and retrofit our covers and spherical seals.

The cover hand tool is available in all sizes for our bearing houses, please also see the below table.

SIZE D	SHAFT DIAMETER D1	SHAFT DIAMETER D1	ARTICLE NUMBER
mm	mm	inches	
47	20	3/4"	8000271
52	25	1"	8000272
62	30	1 1/4"	8000273
72	35	1 3/8"	8000274
80	40	1 1/2"	8000275

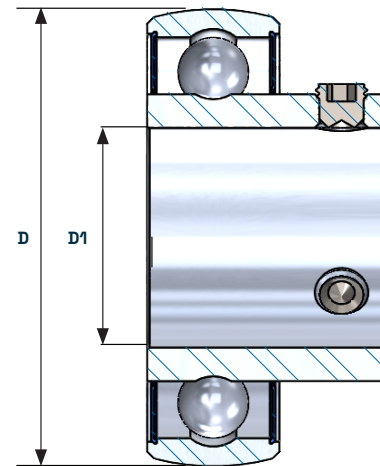

The tool is easy to mount on the cover and ensures an easy assembling as well as disassembling of the bearing houses.

The cover hand tool is orange so it is easy to spot.

